

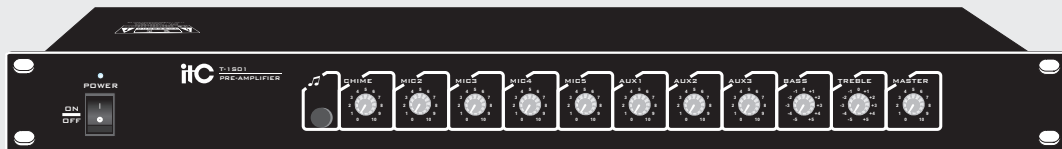

# PUBLIC ADDRESS SYSTEM

# OPERATION MANUAL

## T-1S01 PRE-AMPLIFIER



Please follow the instructions in this manual to obtain the optimum results from this unit.  
We also recommend that you keep this manual handy for future reference.

# TABLE OF CONTENTS

<b>1. SAFETY PRECAUTIONS</b> .....	1
<b>2. ATTENTION</b> .....	2
<b>3. GENERAL DESCRIPTION</b> .....	3
<b>4. FEATURES</b> .....	3
<b>5. FUNCTIONS</b> .....	4
<b>6. OPERATION ILLUSTRATION</b> .....	6
6.1 Power LED .....	6
6.2 Power Switch .....	6
6.3 MIC 1 EXT microphone input .....	6
6.4 MIC (2 ~ 5) balanced microphone / MIC (2 ~ 4) unbalanced input and the GAIN.....	7
6.5 +48 phantom power selector switch .....	7
6.6 EMC input .....	8
6.7 AUX (1 ~ 3) auxiliary input .....	8
6.8 REC recording output interface .....	9
6.9 OUT The balanced line output .....	9
6.9.1 24V DC input .....	10
6.9.2 Power input .....	10
<b>7. DEVICE LAYOUT</b> .....	11
<b>8. MACHINE INSTALLATION PROCEDURES</b> .....	11
<b>9. CONNECTION DIAGRAM</b> .....	12
<b>10. BLOCK DIAGRAM</b> .....	13
<b>11. SPECIFICATIONS</b> .....	14
<b>12. INSTALLING METHOD</b> .....	15

# 1. SAFETY PRECAUTIONS

- Be sure to read the instructions in this section carefully before use.
- Make sure to observe the instructions in this manual as the conventions of safety symbols and messages regarded as very important precautions are included.
- We also recommend you keep this instruction manual handy for future reference.

## Safety Symbol and Message Conventions

Safety symbols and messages described below are used in this manual to prevent bodily injury and property damage which could result from mishandling. Before operating your product, read this manual first and understand the safety symbols and messages so you are thoroughly aware of the potential safety



### WARNING

Indicates a potentially hazardous situation which, if mishandled, could result in death or serious personal injury.



### CAUTION

Indicates a potentially hazardous situation which, if mishandled, could result in moderate or minor personal injury, and/or property damage.



### WARNING

#### When Installing the Unit

- Do not expose the unit to rain or an environment where it may be splashed by water or other liquids, as doing so may result in fire or electric shock.
- Use the unit only with the voltage specified on the unit. Using a voltage higher than that which is specified may result in fire or electric shock.
- Do not cut, kink, otherwise damage nor modify the power supply cord. In addition, avoid using the power cord in close proximity to heaters, and never place heavy objects -- including the unit itself -- on the power cord, as doing so may result in fire or electric shock.
- Be sure to replace the unit's terminal cover after connection completion. Because high voltage is applied to the speaker terminals, never touch these terminals to avoid electric shock.
- Be sure to ground to the safety ground (earth) terminal to avoid electric shock. Never ground to a gas pipe as a catastrophic disaster may result.
- Avoid installing or mounting the unit in unstable locations, such as on a rickety table or a slanted surface. Doing so may result in the unit falling down, causing personal injury and/or property damage.

#### When the Unit is in Use

- Should the following irregularity be found during use, immediately switch off the power, disconnect the power supply plug from the AC outlet and contact your nearest **ITC** dealer. Make no further attempt to operate the unit in this condition as this may cause fire or electric shock.
  - If you detect smoke or a strange smell coming from the unit.
  - If water or any metallic object gets into the unit
  - If the unit falls, or the unit case breaks
  - If the power supply cord is damaged (exposure of the core, disconnection, etc.)
  - If it is malfunctioning (no tone sounds.)
- To prevent a fire or electric shock, never open nor remove the unit case as there are high voltage components inside the unit. Refer all servicing to your nearest **ITC** dealer.
- Do not place cups, bowls, or other containers of liquid or metallic objects on top of the unit. If they accidentally spill into the unit, this may cause a fire or electric shock.
- Do not insert nor drop metallic objects or flammable materials in the ventilation slots of the unit's cover, as this may result in fire or electric shock.

### CAUTION

#### When Installing the Unit

- Never plug in nor remove the power supply plug with wet hands, as doing so may cause electric shock.
- When unplugging the power supply cord, be sure to grasp the power supply plug; never pull on the cord itself. Operating the unit with a damaged power supply cord may cause a fire or electric shock.
- When moving the unit, be sure to remove its power supply cord from the wall outlet. Moving the unit with the power cord connected to the outlet may cause damage to the power cord, resulting in fire or electric shock. When removing the power cord, be sure to hold its plug to pull.
- Do not block the ventilation slots in the unit's cover. Doing so may cause heat to build up inside the unit and result in fire.
- Avoid installing the unit in humid or dusty locations, in locations exposed to the direct sunlight, near the heaters, or in locations generating sooty smoke or steam as doing otherwise may result in fire or electric shock.

#### When the Unit is in Use

- Do not place heavy objects on the unit as this may cause it to fall or break which may result in personal injury and/or property damage. In addition, the object itself may fall off and cause injury and/or damage.
- Make sure that the volume control is set to minimum position before power is switched on. Loud noise produced at high volume when power is switched on can impair hearing.
- Do not operate the unit for an extended period of time with the sound distorting. This is an indication of a malfunction, which in turn can cause heat to generate and result in a fire.
- Contact your **ITC** dealer as to the cleaning. If dust is allowed to accumulate in the unit over a long period of time, a fire or damage to the unit may result.
- If dust accumulates on the power supply plug or in the wall AC outlet, a fire may result. Clean it periodically. In addition, insert the plug in the wall outlet securely.
- Switch off the power, and unplug the power supply plug from the AC outlet for safety purposes when cleaning or leaving the unit unused for 10 days or more. Doing otherwise may cause a fire or electric shock.

An all-pole mains switch with a contact separation of at least 3 mm in each pole shall be incorporated in the electrical installation of the building.

### 3. GENERAL DESCRIPTION

The series is pre-amplifier. They are designed with the latest style so it is easy to meet the requirements from mini to medium Public address system. Pre-amplifier is connector with various audio sources (including common audio sources, such as CD player, tuner, cassette, MP3 player etc., special audio sources such as fire alarm generator, and various microphone sources) and power amplifier. The volume of each line audio input can be controlled separately, with the priority ordering function. It means T-1S01 can be order priority to the audio input according to the requirement, with the chime generator, and it could offer the warning tone for the paging. Pre-amplifier also has the control function of tonal quality, for example, T-1S01 can make the sound from power amplifier be met the need of listeners through controlling circuit by volume control or Equal-loudness, regulate and control the signal and frequency, reach the function of sound modification and beautification.

### 4. FEATURES

1. Standard chassis design, 1U aluminium alloy; light equipment, simple operation, artistic and practical
2. MIC 2-3-4-5 input, Aux 1-2-3 input, EMC input, REC input
3. MIC 1 is the first priority input, CHIME and EXT MIC is the second priority, EMC is the third priority input, auto input is the most priority than all the other input.
4. Each line input for the separate volume and master volume regulation
5. MIC 2-3-4-5 input has +48 phantom power switch
6. With chime generator, offering prompt tone for paging
7. It can be worked with T-319.
8. 24V spare power input

## 5.FUNCTIONS(Front Panel)

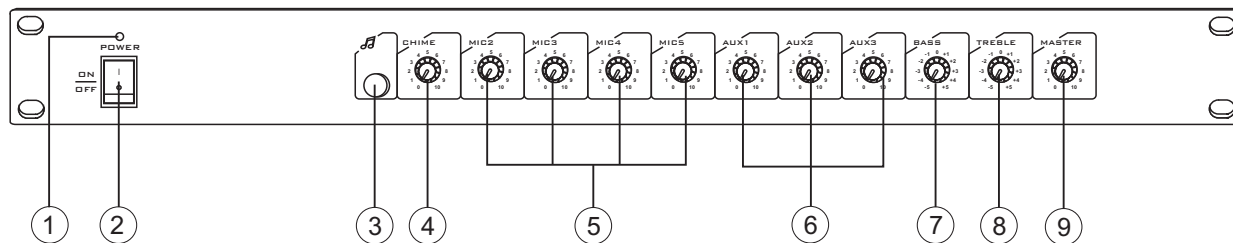

1. Electricity Indicator (red)
2. Power Switch
3. Chime Control Button
4. Chime Volume Control
5. Mic(2-5) Volume Control
6. Aux (1-3) Volume Control
7. Bass Volume Control
8. Treble Volume Control
9. Master Volume Control

## FUNCTIONS(Rear Panel)

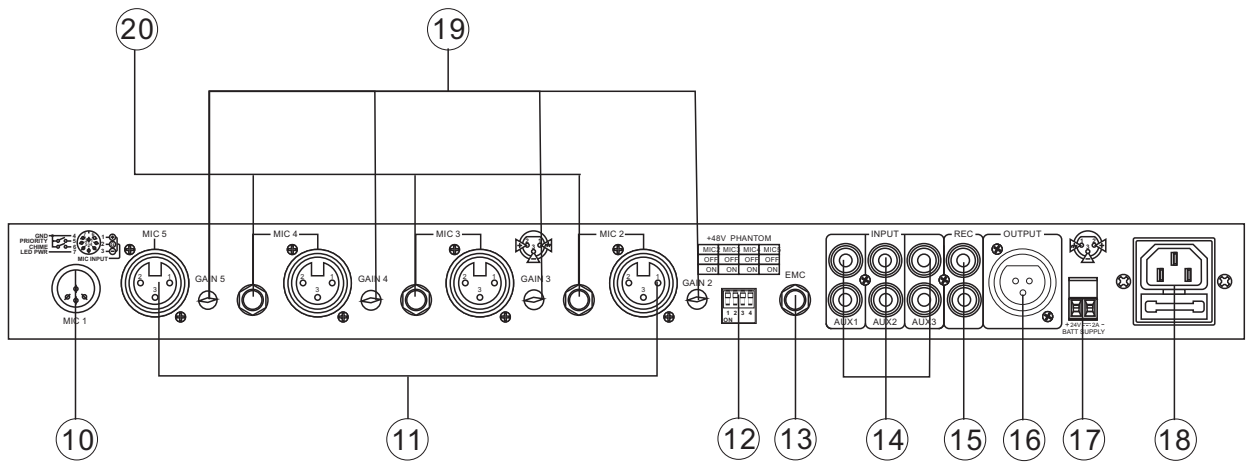

10. Mic1 insert connects with T-319

11. Mic(2-5) balance (XLR) mic input

12. Mic(2-5) phantom +48V power option switch

13. EMC input

14. AUX (1-3) input

15. REC input

16. Output(XLR)

( connect with high-power amplifier)

17. DC 24V spare power input

18. AC power input

19. Mic channel Gain control

20. Mic(2-4) unbalance(TRS) mic input

## 6. OPERATION ILLUSTRATION

### 6.1 Power LED 6.2 Power Switch

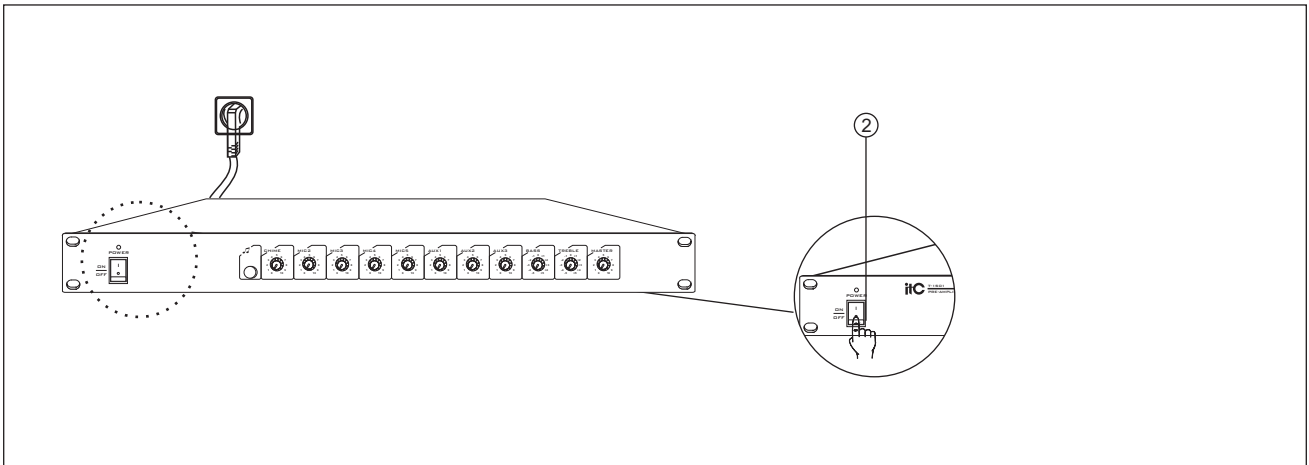

Fig 6.1/6.2

When hit the power switch "ON" -power up, power indicator light (red) light.  
When hit the power switch "OFF", the power off, power indicator light (red) out.  
The switch can not control the +24V switch.

**i** Note:  
In order to work properly, equipment must be confirmed in a normal power state. If the machine fails, please contact the vendor.

### 6.3 Mic1 EXT microphone input

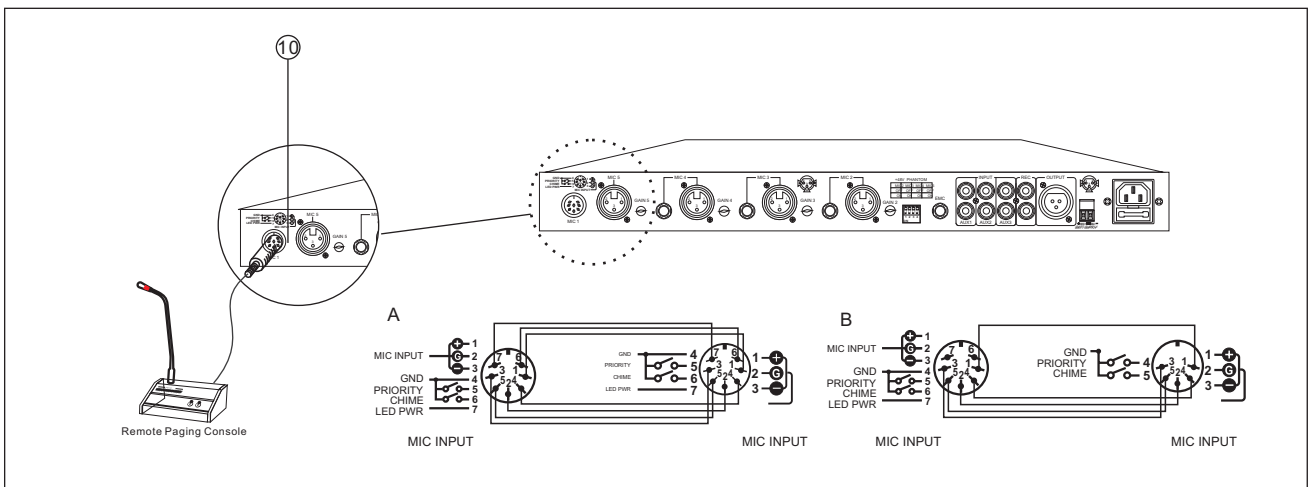

Fig 6.3

Mic1 microphone connect to pre-amplifier with 7-pin or 5 pin interface, when the Mic1 microphone input with priority function, Mic1 can be expanded to a mAX Audioium distance of 30 meters.

**i** Note:  
When input microphone , the device must be matched with a remote microphone (Remote Paging Console), otherwise access can not be functional.



## 6.4 MIC (2 ~ 5) balanced microphone / MIC (2 ~ 4) unbalanced input and the GAIN

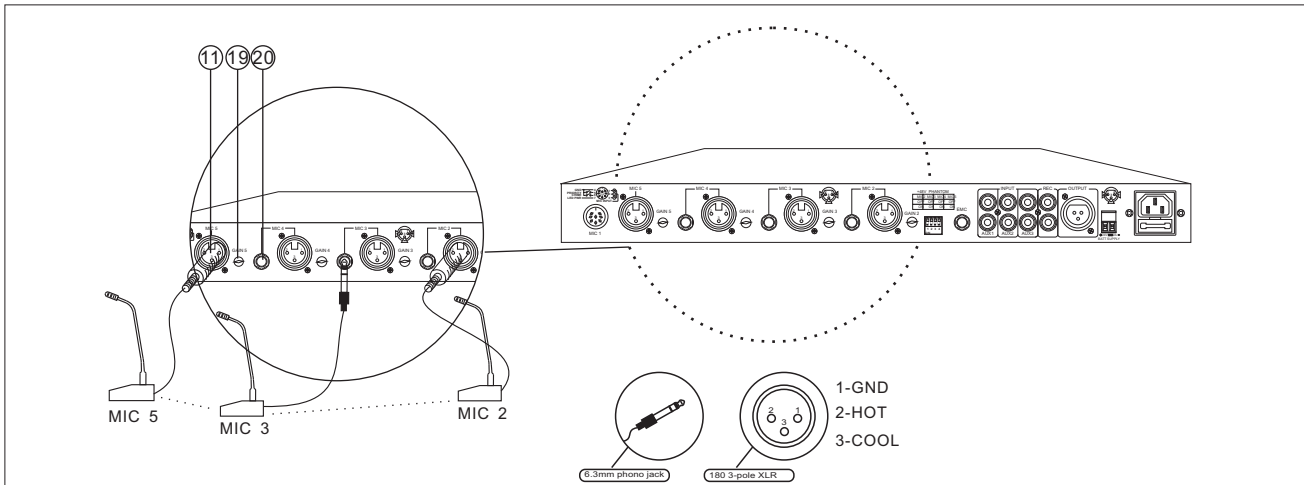

MIC (2 ~ 5) microphone input, adopt balanced microphone (XLR) input, MIC (2 ~ 5) balanced microphone input adopt MIC (2 ~ 5) the size of a balanced microphone input volume by the panel MIC (2 ~ 5) / MASTER adjustment control knob and, in conjunction with BASS / TREBLE adjust the volume knob to achieve the desired effect of hearing. MIC (2 ~ 4) microphone input, may also have recourse to TRS jack input. When the microphone MIC 1 input signal, the highest priority to check the other input signal jack. At the same time, MIC (2 ~ 5) can adjust the microphone gain. MIC input gain can be controlled in +10 ~ +44 dB. by adjusting the size,



### Note:

1. Before input the microphone, the volume must be transferred to the minimum to avoid sound exposure.
2. When input Microphone, TRS connector / XLR connector can only select a permanent input; otherwise, sound quality will be affected.
3. Ensure complete microphone input otherwise it does not work.

## 6.5 +48 phantom power selector switch

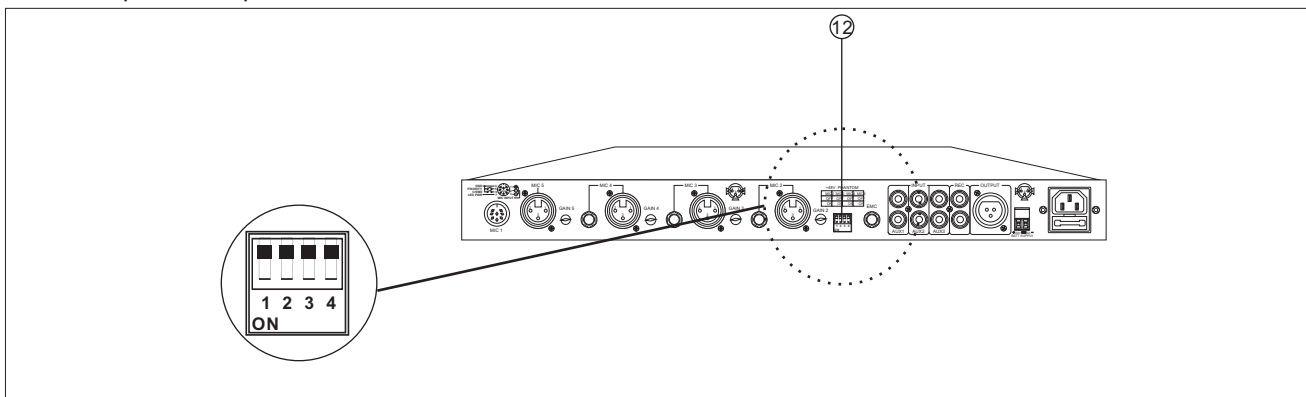

Fig 6.5

MIC (2 ~ 5) balanced (XLR) microphone input with +48 V phantom power supply switch control. When the power supply +48 V phantom power switch when the next call (ie, hit "ON" position), indicating that the MIC (2 ~ 5) have a +48 V phantom power to connect MIC (2 ~ 5) of the external equipment. +48 Phantom power switch when the time allocated (ie, hit "OFF" position), indicating that the MIC (2 ~ 5) +48 V phantom power to stop.



### Note:

+48V phantom power to open, it must first be transferred to the minimum volume position, to avoid sending the sound exposure.

## 6.6 EMC input

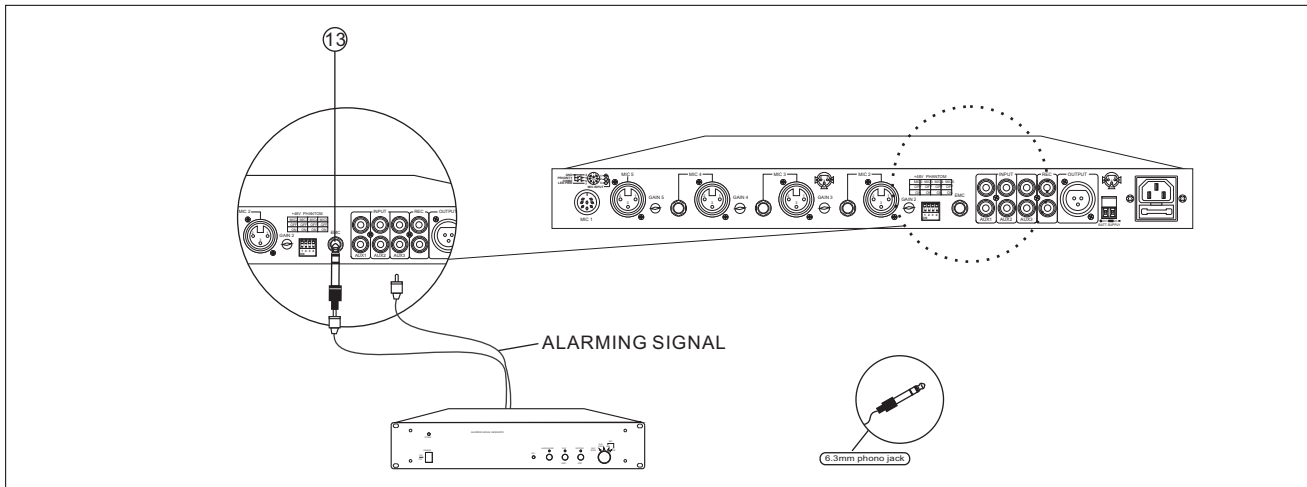

Fig 6.6

EMC emergency input, EMC urgent priority input function with the third level, when the emergency importation of EMC, we can cut off (in addition to MIC 1, EXT MIC, CHIME) to play other audio input.

**i** Note:  
EMC emergency input, volume is not controlled by the panel adjusting knob. It depends on the amplitude of the signal input.

## 6.7 AUX (1 ~ 3) auxiliary input

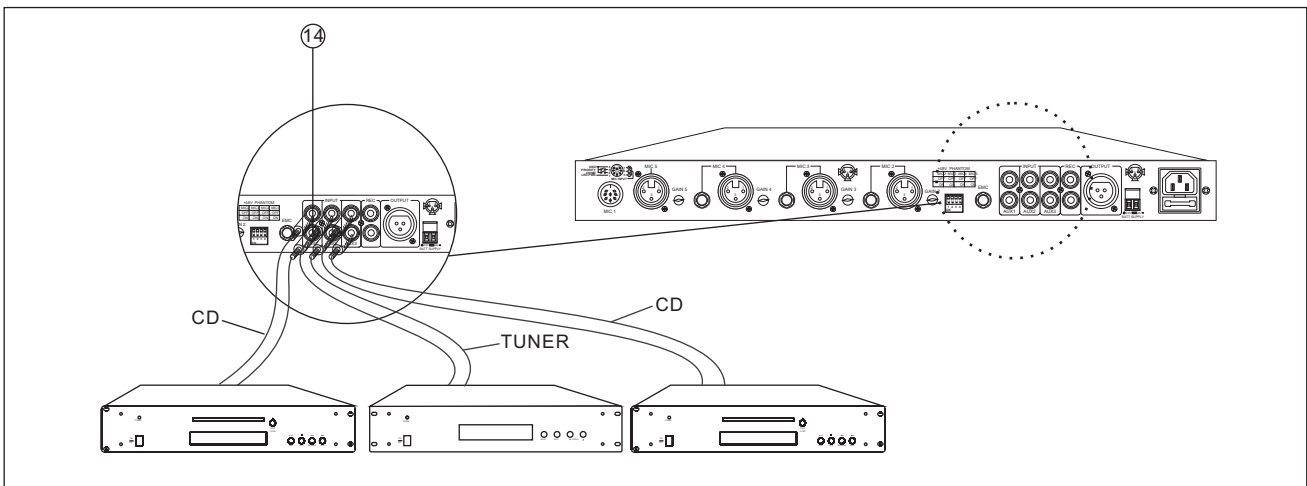

Fig 6.7

AUX (1 ~ 3) auxiliary input, volume is controlled by the AUX (1 ~ 3) / MASTER knob on the panel, in conjunction with BASS / TREBLE volume adjustment knob to obtain idea hearing effect. AUX (1 ~ 3) auxiliary input with RCA connectors input, machinery and equipment can be connected CD/MP3/TUNER run.

**i** Note:  
When using the auxiliary input, you must position the volume must be posited to a minimum, to avoid the sound exposure.

## OPERATION ILLUSTRATION

### 6.8 REC recording output interface

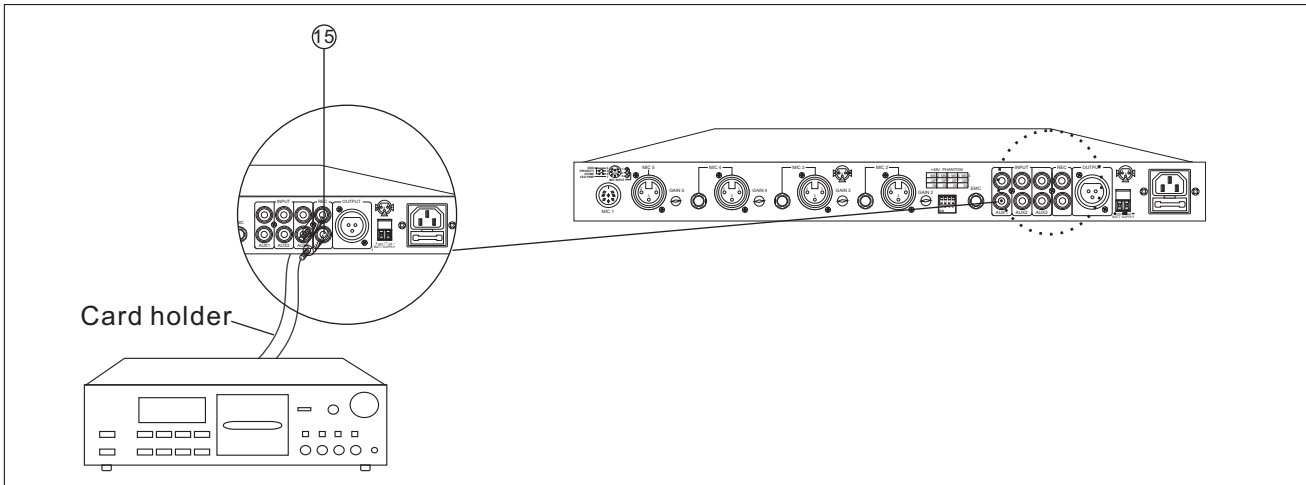

Fig 6.8

REC recording output interface, it can connect cassette equipment. The volume can adjusting and control by MASTER knob, combining the BASS/TREBLE volume knob to make ideal sound effects.

### 6.9 OUT The balanced line output

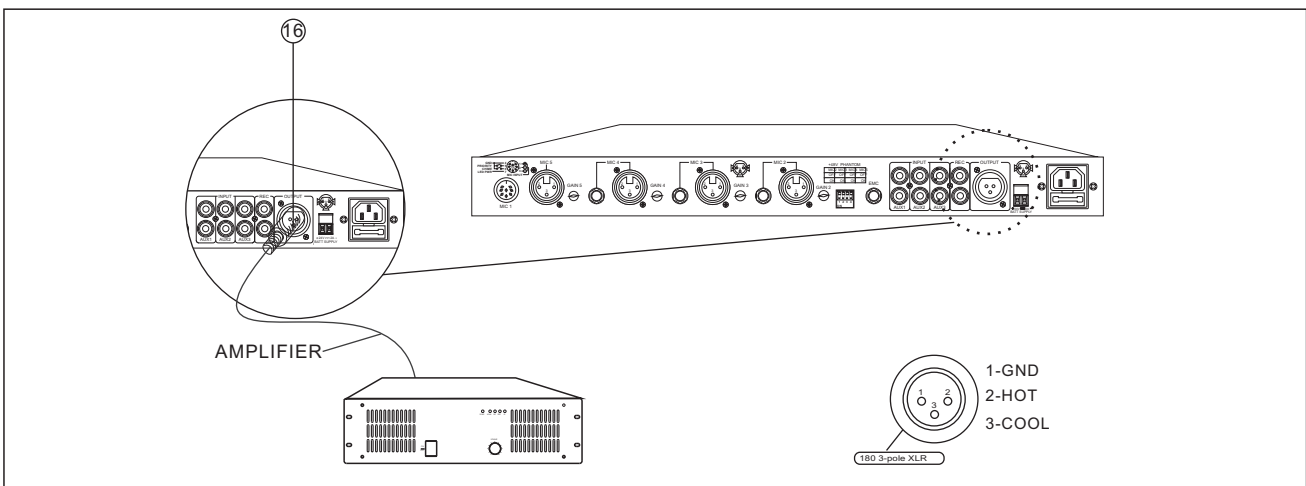

Fig 6.9

The balanced line XLS output. The volume can adjusting and control by MASTER knob, combining the BASS/TREBLE volume knob to make ideal sound effects. This function provides the power amplifier to use as pre- amplifier of enlarge signal, with the power function expansion.

#### **i** Note:

Output balance XLS line output connect with amplifier input interface, must adjust volume to Intermediate position to avoid sending aeration.

## OPERATION ILLUSTRATION

### 6.9.1 24V DC input

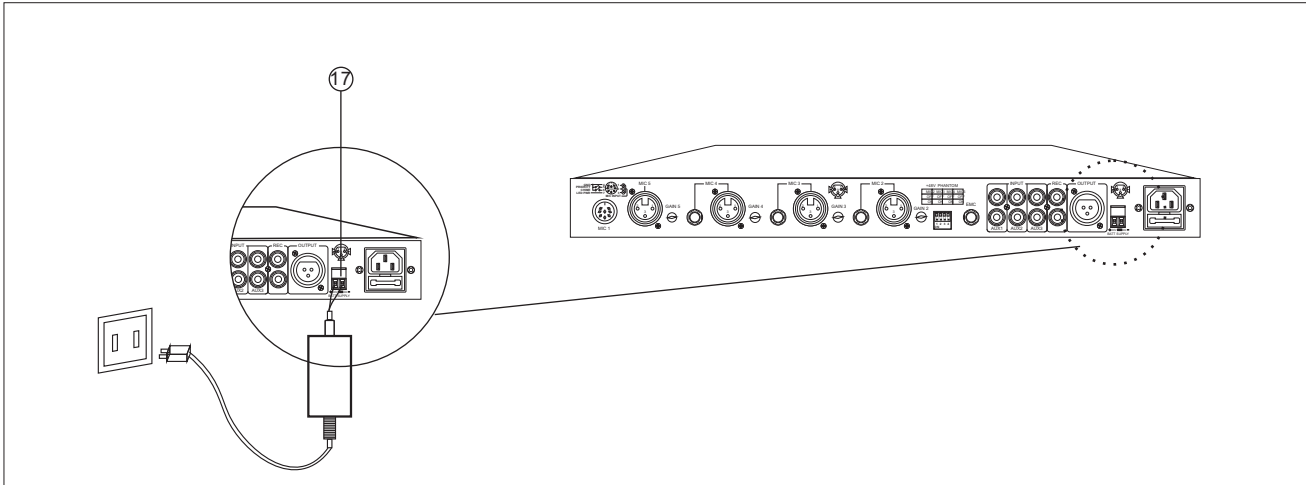

Fig 6.9.1

When ~220V-240V power is cut off supply (such as line was cut off in the emergency), 24V DC power supply electricity to equipments.

#### **i** Note:

1. Use 24V DC input, must use within the specified range security power input, avoid to cause accidents.
2. Without use 24V DC power supply, please uproot, avoid to cutting down power use life.

### 6.9.2 Power input

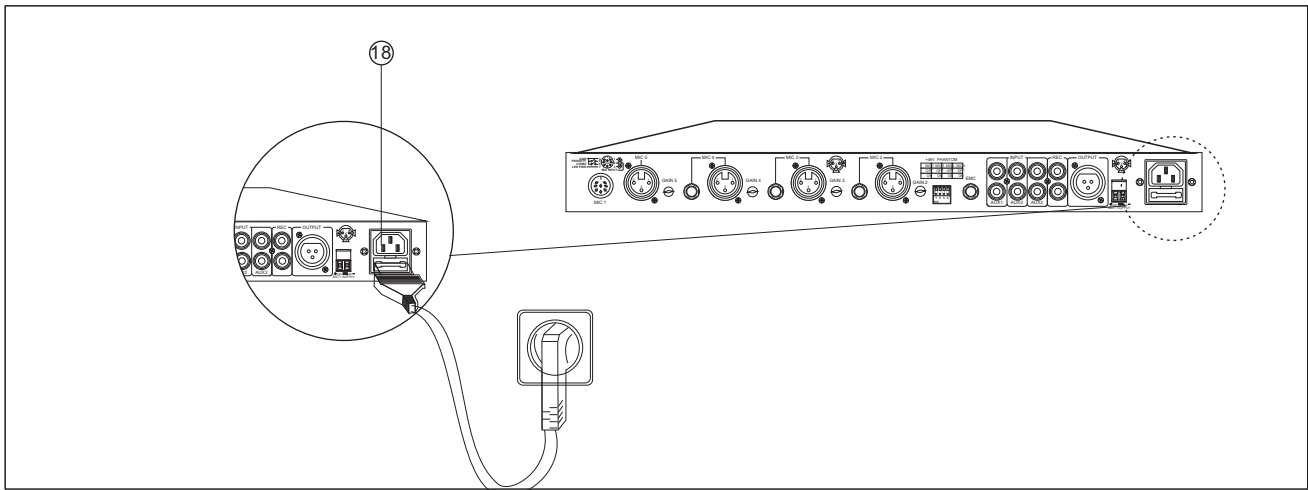

Fig 6.9.1

Power is to provide energy to equipment, must be safe use of power supply, don't use it, please pull power.

#### **i** Note:

When used it, must use the security power input within the stipulated scope, avoid causing accidents.

## 7. DEVICE LAYOUT

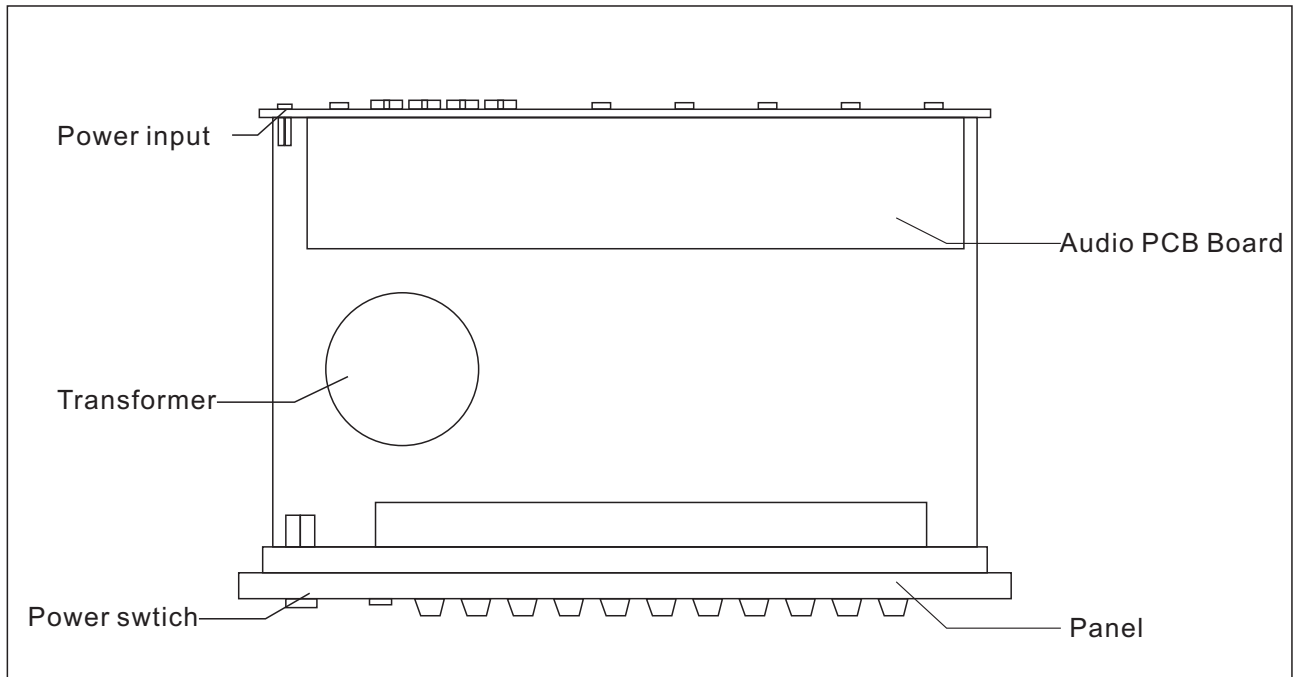

## 8. MACHINE INSTALLATION PROCEDURES

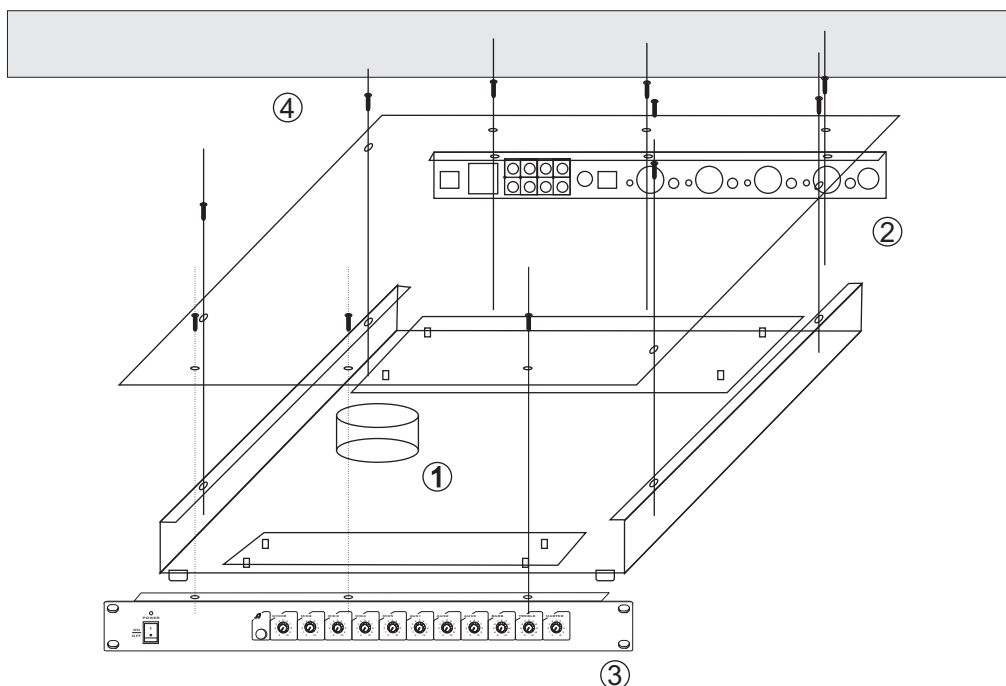

1. Firstly, install board inside the machine with wiring.
2. After install the back panel and floor with screws.
3. Then install equipment panel.
4. Finally, to install cover.



Note:

- 1.the equipment adopts 4X4mm screws. 2 when installation, keep equipment clean.
3. Undertake certain temperature conditions, installing equipment.

# 9.CONNECTION DIAGRAM

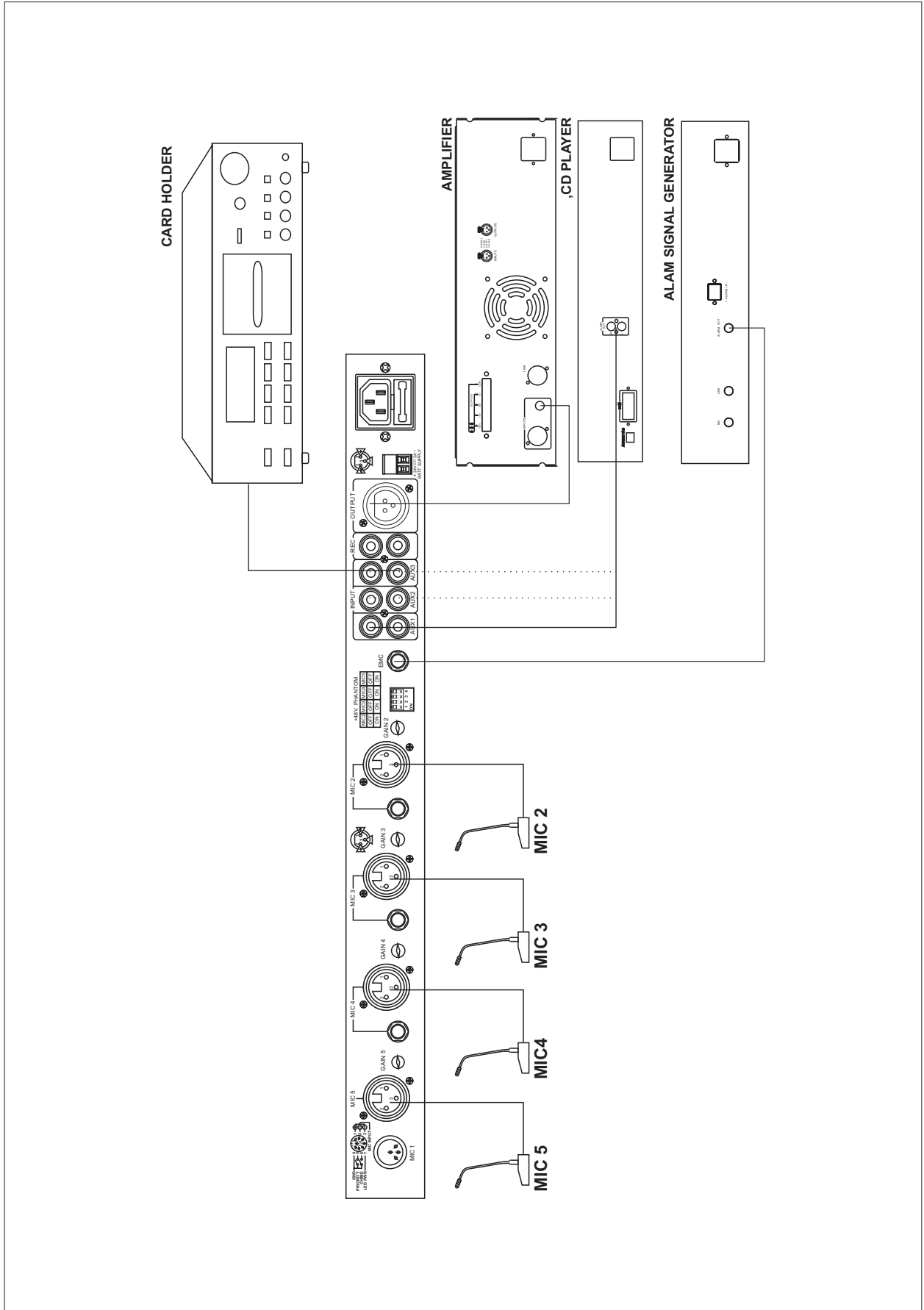

# 10. BLOCK DIAGRAM

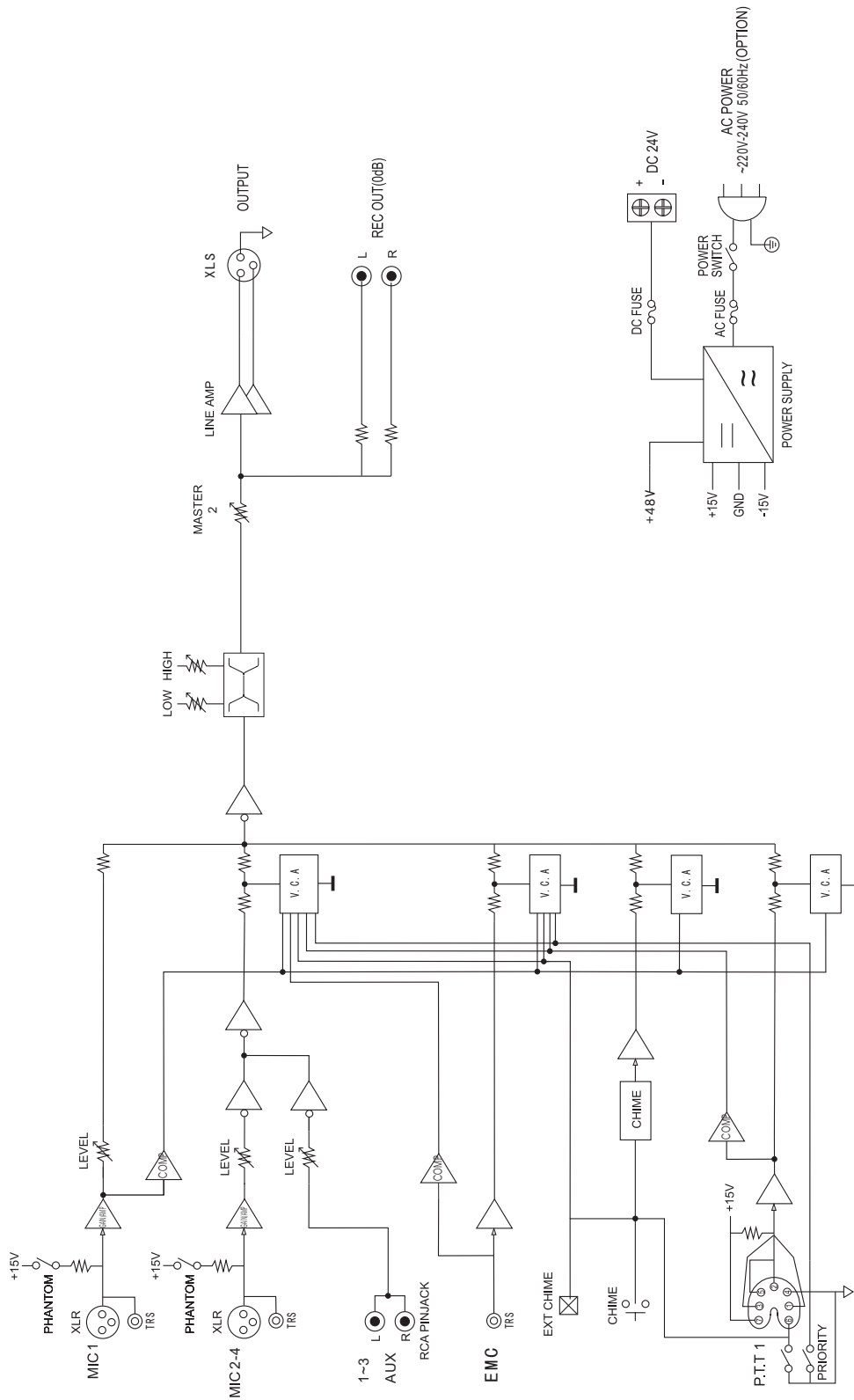

## 11. SPECIFICATIONS

MODEL	T-1S01
INPUT	MIC 2,3,4,5: 2.5mv/2KOhms balance, 5mv/1KOhms Unbalance AUX 1,2,3: 10KOhms/300mVUnbalance EMC: 775mV/15KOhms Unbalance
OUTPUT	775mV 600Ohms
ADJUST VOLUME	BASS: $\pm 10$ dB at 100Hz TREBLE: $\pm 10$ dB at 10KHz
FREQUENCY RESPONSE	20Hz~20KHz( $\pm 1$ dB)
POWER INPUT	~220-240V 50/60Hz
DIMENSION	484X295X44mm
NET WEIGHT	3.75Kg
GROSS WEIGHT	4.75Kg



## 12. INSTALLING METHOD

Unit:mm

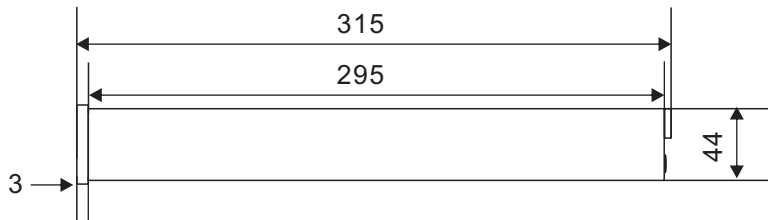
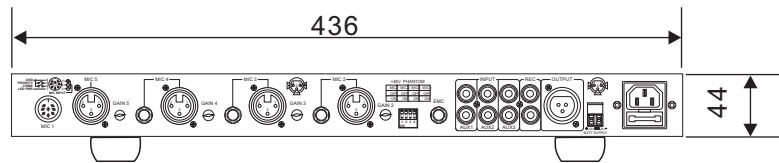
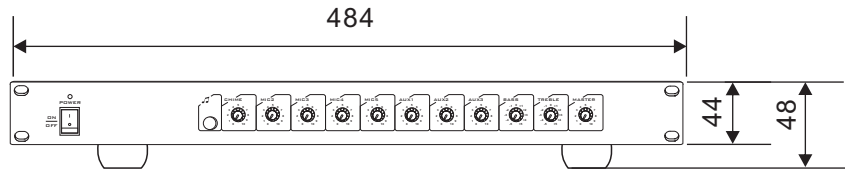

Keep the unit's all sides over 10 cm away from objects that may obstruct air flow to prevent the unit's internal temperature rise.

Unit:mm

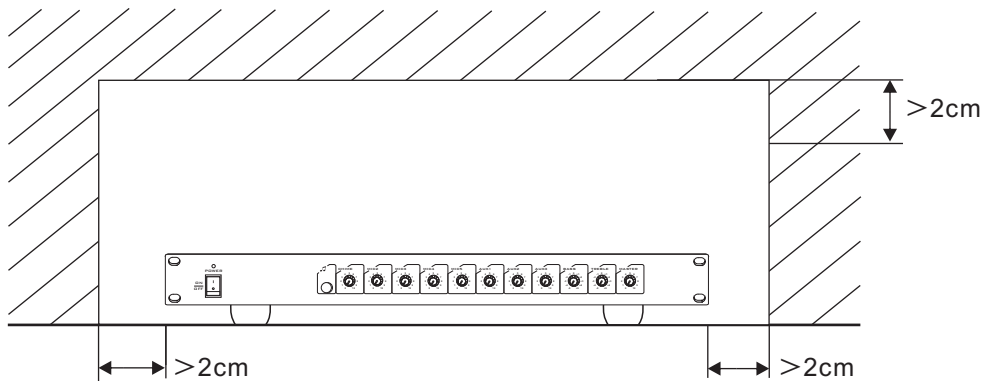

# PUBLIC ADDRESS SYSTEM

